

# TYOLOGIES

FIXED

MONORAIL



BIRAIL

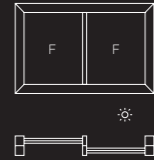

SLIDING

BIRAIL

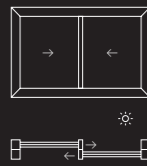

TRIRAIL

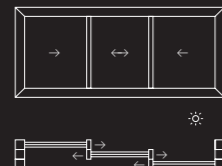

SLIDING AND FIXED

BIRAIL

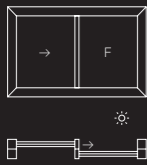

TRIRAIL

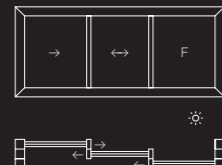

BIRAIL

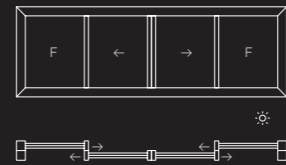

SLIDING AND POCKET

BIRAIL

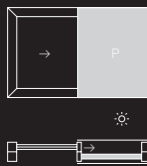

TRIRAIL

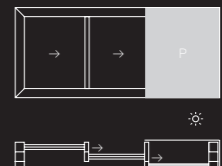

BIRAIL

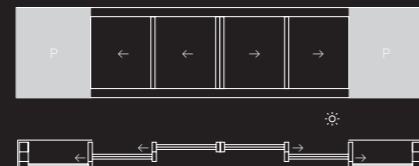

SLIDING CORNER

BIRAIL

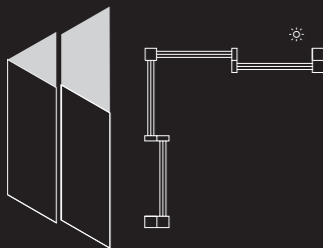

SLIDING CORNER POCKET

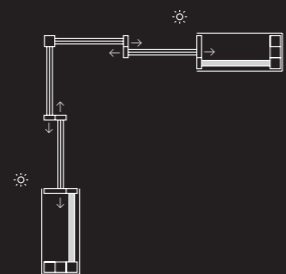

TRIRAIL



A BYSTEEL FS BRAND

by  
steel<sub>fs</sub>

RUA DE PITANCINHOS, S/N  
4711-911 PALMEIRA, BRAGA  
(+351) 253 307 204  
GERAL@LYRICAL-DESIGNWINDOWS.COM

INSTAGRAM.COM/LYRICAL.DESIGNWINDOWS  
LINKEDIN.COM/LYRICAL-DESIGNWINDOWS  
LYRICAL-DESIGNWINDOWS.COM

LYRICAL MUS

# LYRICAL MUSE I

GLASS  
SIMPLE  
INSULATION  
UP TO 16 MM  
CLIMATES  
WARM

Discover the simplicity and elegance of the LYRICAL MUSE I system. Designed for both indoor and outdoor environments in hot climates, this hyper minimalist solution adapts to any space. With acoustically treated glass, it is perfect for internal fixed or sliding partitions, providing tranquility and ambience, in perfect aesthetic harmony. Its modular structure was created to allow easy customisation and adaptation to different project configurations, making it a versatile choice for architects and interior designers.

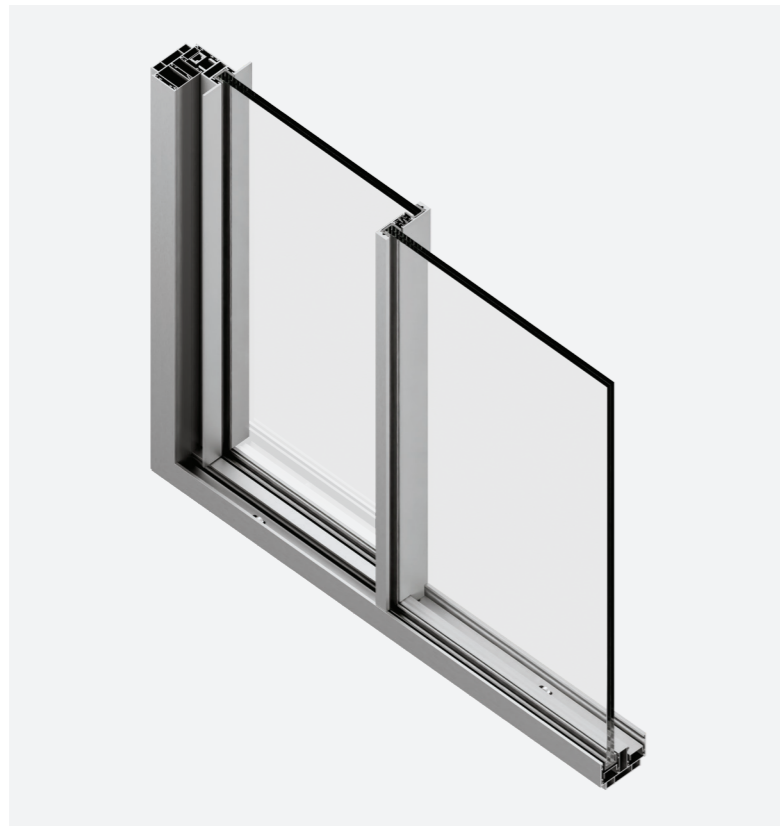

# LYRICAL MUSE II

GLASS  
DOUBLE  
INSULATION  
UP TO 38 MM  
CLIMATES  
HYBRID

The LYRICAL MUSE II hybrid system combines aluminum, polyamide and fiberglass for superior thermal performance and maximum efficiency. By maximising the glazing area and minimising opaque profiles, it offers versatile solutions for façades with multiple operable sheets. In addition to exceptional thermal insulation, it stands out for its airtightness, wind resistance, air permeability, safety and acoustic attenuation. With a reinforced structure, it integrates advanced automation and security technologies, making it ideal for architectural projects that combine comfort and protection.



## PERFORMANCE

THERMAL TRANSMITTANCE ( $U_g = 1.0$ )	$U_w = 1,22 \text{ W/m}^2\text{K}$ (EN 10077)
AIR PERMEABILITY	CLASS 4 (EN 12207)
WATER TIGHTNESS	E750 (EN 12208)
WIND LOAD RESISTANCE (Standard interlock)	A5 (EN 12210)
SOUND INSULATION	Rw 41 dB (EN ISO 717-1)
SECURITY	RC2 / WK2 (EN 1628, 1629, 1630)

# LYRICAL MUSE III

GLASS  
TRIPLE  
INSULATION  
UP TO 52 MM  
CLIMATES  
COLD

The LYRICAL MUSE III system combines advanced technology, elegant design and high performance. Compatible with triple hyper-insulated glass up to 52 mm, it is ideal for cold climates, ensuring energy efficiency, thermal and acoustic comfort, as well as high security against intrusions. It allows the integration of large-scale glass panels, up to 12 meters high, with smooth sliding system, making it perfect for those who value sophistication and functionality.



## PERFORMANCE

THERMAL TRANSMITTANCE ( $U_g = 0.5$ )	$U_w = 0,72 \text{ W/m}^2\text{K}$ (EN 10077)
AIR PERMEABILITY	CLASS 4 (EN 12207)
WATER TIGHTNESS	E750 (EN 12208)
WIND LOAD RESISTANCE (Standard interlock)	A5 (EN 12210)
SOUND INSULATION	Rw 44 dB (EN ISO 717-1)
SECURITY	RC2 / WK2 (EN 1628, 1629, 1630)

